



Application booklet  
Sound walls & Acoustic screens



All information herein described for POLYCARBONATE CLEAR UV is valid for: POLYCARBONATE COLOURED UV, POLYCARBONATE SAPHIR HC, and POLYCARBONATE SAPHIR SPD, unless stated otherwise.

In order to determine the right product for the right application, it is important to understand the technical basics.

## CONTENTS

- 1 Sound explained
  - 1.1 Sound pressure level
  - 1.2 Loudness
  - 1.3 Distance from the noise source
  - 1.4 Sound absorption, sound insulation and sound reflection
- 2 Outdoor noise reducing measures
  - 2.1 noise barriers
  - 2.2 requirements
  - 2.3 installation
- 3 Indoor noise reducing measures
  - 3.1 double glazing
  - 3.2 secondary glazing
  - 3.3 sound screen
  - 3.4 machine glazing

## 1 SOUND EXPLAINED

Sound is the vibration of matter, as perceived by the sense of hearing. Physically, sound is vibrating mechanical energy that propagates through matter as a wave.

Through gases and liquids sound is transmitted as longitudinal waves (compression waves). Through solids, it can be transmitted as both longitudinal and transverse waves. Longitudinal sound waves are waves of alternating pressure deviations from the equilibrium pressure, causing local compression and rarefaction regions. Transverse waves in solids are waves of alternating shear stress.

Matter in the medium is periodically displaced by a sound wave, and thus oscillates. The energy carried by the sound wave is split equally between the potential energy of the extra compression (in case of longitudinal waves) or strain (in case of transverse waves) of the matter and the kinetic energy of the oscillations of the medium.

Sound has a repetitive character which makes it possible for us to sense it (hearing).. This repetition is called the frequency of sound and is expressed in Hertz (Hz), which indicates the number of repetitions per second. Humans can sense sound in the frequency range of 20 to 16 000 Hz (16 kHz).

### SOUND CAN BE DIVIDED IN 3 GENERAL CLASSES:

- Low tones: 20 - 400 Hz
- Middle tones: 400 - 1600 Hz
- Sharp tones: 1600 - 16 000 Hz

### 1.1 Sound Pressure Level (SPL)

Sound intensity is expressed in dB with respect to one picoW/m<sup>2</sup> (0.00000000001 Watt per m<sup>2</sup>), which equals the sound pressure level (SPL) in dB when measured 30 cm from the noise source.

For a plane wave, the sound power that passes through a surface is defined as the ratio of the pressure squared to the impedance ( $\rho \cdot c$ )

$$I = P^2 / (\rho \cdot c)$$

P = Pressure

$\rho$  = density (for air: 1.21 kg/m<sup>3</sup>)

c = speed of sound (for air: 340 m/s)

Numerically, the sound intensity is related to the sound power as follows:

In free air space, a source emitting Lw dB re 1 pW produces an SPL Lp at a distance R meter of:

$$L_p = L_w - 20 \log R - 0.6$$

At 30 cm, that sound power is distributed over a surface of  $4 \cdot \pi \cdot 0.3^2 = 1.13 \text{ m}^2$

$$10 \log 1.13 = 0.5 \text{ dB}$$

Sound intensity meters are popular for determining the quantity and location of sound energy emission.

### 1.2 Loudness

Loudness (Lp) is the character of an audible impression which makes it possible to differentiate between a quiet and a loud sound. It is in close interaction with sound pressure and dependant on the amplitude of the vibrations.

The unit for loudness is deciBel (dB).

The hearing limit (0 dB) is the lowest level where the human ear senses sound.

The pain limit (120 dB) is the maximum level for painless hearing.

Examples	Sound Pressure Level Lp, dB SPL	Sound Pressure $\rho$ N/m <sup>2</sup> = Pa	Sound Intensity I W/m <sup>2</sup>
Jet aircraft, 50 m away	140	200	100
Pain limit	130	63.2	10
Limit of discomfort	120	20	1
Kerbside of busy road, 5 m	80	0.2	0.0001
Conversational speech, 1m	60	0.02	0.000001
Rustling leaf	10	0.000063	0.0000000001
Hearing limit	0	0.00002	0.000000000001

Our hearing is less sensitive to very low and very high frequencies. In order to incorporate this, weighing filters are used. Most common is the A-filtering, which gives measurements expressed in dB(A).

dB (A), dB(C) are other standards that in addition introduces a "weighing" of the frequency range, in order to, for instance, 'mimic' the human hearing, which is not equally acute over the whole perceptible spectrum. A 20 Hz tone (the deepest bass humans can hear) needs to have a sound pressure level of 70 dB (SPL) in order to be perceived as equally loud as a 1.000 Hz tone at 0 dB (SPL). In other words, our hearing is much more acute in the "middle range", than in the bass and treble areas.

The equal loudness curves (in Phon), shows how our hearing varies over different frequency ranges, and also, according to how loud the sound stimuli are. (The louder sounds, the less difference over the frequency range).

Doubling the absorbing mass increases the sound reduction with 3 dB. A change of 10 dB is perceived by humans as a halving (doubling) of the noise level.

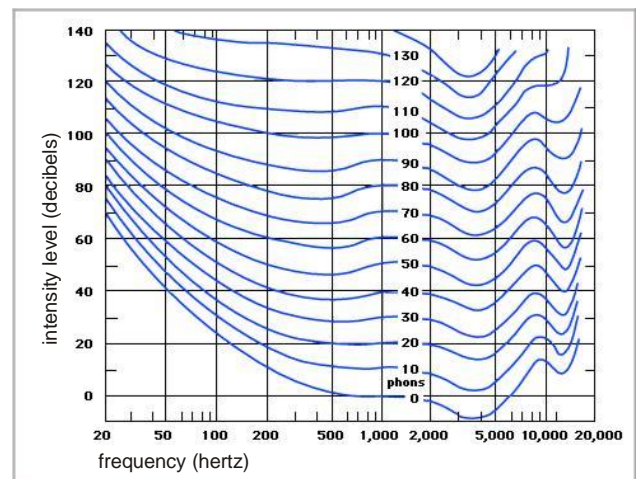

## Types of sound:

It is obvious that there are different sound spectra, depending on the type of noise.

The noise of playing children on a school playground is not comparable with heavy truck traffic.

To reduce lower frequencies, mass is needed: a large humming machine will often be built on a concrete block.

For higher frequencies, flexibility is better: High tones are well reduced using foam or rubber.

In order from highest annoyance: Air noise, traffic noise, railroad noise, industry noise.

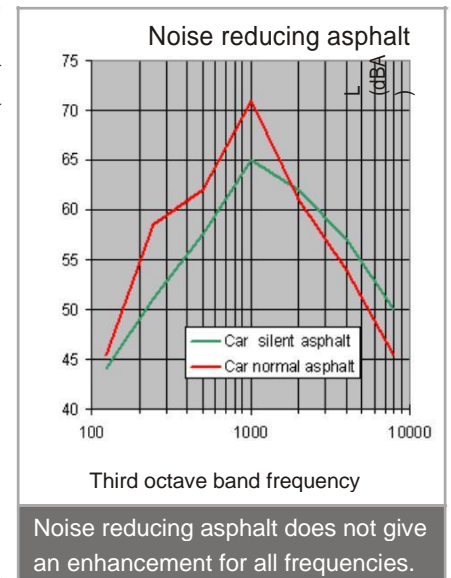
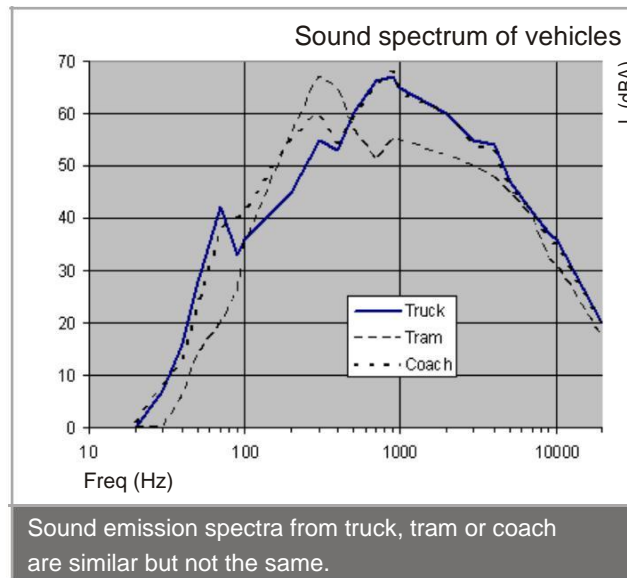

### 1.3 Distance from the noise source

At distances large compared to the size of the source, sound intensity ( $I$ ) diminishes according to the inverse square law, provided the source is small (ideally a point source), and outdoors (for larger and/or indoor sources the relation is more complex).

$$I = I_0/D^2$$

Hereby the sound level declines by 6 dB for each doubling of distance.

Line noise sources such as a long line of moving traffic will radiate noise in cylindrical pattern, so that the area covered by the sound energy spread is directly proportional to the distance and the sound will decline by 3 dB per doubling of distance.

Close to a source (the near field) the change in SPL will not follow the above laws because the spread of energy is less, and smaller changes of sound level with distance should be expected.

If the observation is at a distance that is small compared to the size of the source, the sound level changes very little with location in that source area. One may be able to determine the "virtual centre" of the whole sound field, whence inverse square law calculations can proceed in reference to that distance, for locations outside the source area.

The surrounding environment, especially close to the ground, and in the presence of wind & vertical temperature gradients (as air density and speed of sound are temperature dependant), has a great effect on the sound received at a distant location. Ground reflection affects sound levels more than a few feet away (distances greater than the height of the sound source or the receiver above the ground). Wind and air temperature gradients affect all sound propagation beyond 100 meters over the surface of the earth. Sound propagates well downwind (travelling with the wind), and very little upwind. When the ground surface is cooler than the air just above it (inversion; typically late at night and just before dawn), sound will travel great distances across the landscape even without any wind.

In addition attenuation due to the absorption of sound by the air is substantial at higher frequencies.

For ultrasound, air absorption may well be the dominant factor in the reduction.

## 1.4 Sound absorption, sound insulation and sound reflection

---

There is often confusion between sound insulation and sound absorption.

Sound absorbing: the material will convert some or all of the sound into heat, or allows the sound to pass through (in any way, not to return). For this reason good sound absorbers do not of themselves make good sound insulators. Sound absorbers contribute little to sound insulation. They are treated separately in sound control design.

Sound insulation prevents sound from travelling from one place to another, such as between apartments in a building, or to reduce unwanted external noise inside a concert hall. Sound insulators rarely absorb sound. Heavy materials like concrete are the most effective materials for sound insulation - doubling the mass per unit area of a wall will improve its insulation by about 6dB. It is possible to achieve good insulation over most of the audio frequency range with less mass by instead using a double leaf partition (two independent walls separated by an air gap filled with a sound absorber).

Sheet with a flat closed surface (like solid or multiwall sheet) therefore gets its sound reduction mainly by sound reflection.

### Standards (sound-reduction related)

---

The measurement method depends on the particular situation. There are standards for the measurement of the insulation of materials in the laboratory, and for a number of different field circumstances. Usually test procedures (e.g. ASTM E-90 in the lab and ASTM E336 in the field) generate a loud and consistent broadband spectrum of steady noise on one side of a partition or specimen of the material under test, and then measure the amount of this sound that passes through that material. The ratio of the incident sound to the transmitted sound is the "noise reduction", usually expressed as  $10\log$  of this ratio. If the noise reduction is also corrected for the amount of sound absorption to be found in the receiving room, 10 times the logarithm of the corrected ratio is called the "transmission loss".

This is performed for 1/3 octave bands of noise from 100 to 4000 Hz.

In Europe, this procedure is ISO 717 and ISO140-3. The fitted range is from 100-3150 Hz. This single number rating is called R' and R respectively.

In the US, ASTM E492 produces the noise reduction and transmission loss data in the same way. But the single number rating is according to ASTM E413 which uses data in the 125-4000 Hz range. The value of that curve at 500 Hz is called the Noise Isolation Class (NIC) or Sound Transmission Class (STC) respectively.

Formerly, most used standard was the German ZTV LSW 88 directive, which is now surpassed by the European Standards in this field - EN 1793 and EN 1794:

#### EN 1793-1:2017

Road traffic noise reducing devices. Test method for determining the acoustic performance. Intrinsic characteristics of sound absorption

=>Sound absorption: EN 1793-1: A Classes : not applicable for our sheet.

#### EN 1793-2:2018

Road traffic noise reducing devices. Test method for determining the acoustic performance. Intrinsic characteristics of airborne sound insulation

#### EN 1793-3:1998

Road traffic noise reducing devices. Test method for determining the acoustic performance. Normalized traffic noise spectrum

EN 1793-4:2015

Road traffic noise reducing devices - Test method for determining the acoustic performance Extrinsic characteristics - in situ efficiency

EN 1793-5:2016

Road traffic noise reducing devices - Test method for determining the acoustic performance Extrinsic characteristics - in situ values of sound absorption and airborne sound insulation

EN 1793-6:2018

Road traffic noise reducing devices - Test method for determining the acoustic performance Intrinsic characteristics - in situ values of the diffraction index difference of added devices placed on the top of acoustic barriers

Sound insulation: EN 1793-2: B-Classes: Best obtainable class B3 DLR >24dB.

EN 1794-1:2018

EN 1794-2:2020

EN 1794-3:2016

Road traffic noise reducing devices. Non-acoustic performance. Ignitability and burning behaviour of materials and products.

Sound Transmission Class (STC) measured according to ISO 717 / DIN 52210-75 (Rw) Both ISO and DIN cover the sound frequency range from 100 Hz - 3150 Hz. This measurement is nowadays mostly done according to ISO 140-3.

	STC	Rw
8 mm POLYCARBONATE CLEAR UV	31,0 dB	25,9 dB
10 mm POLYCARBONATE CLEAR UV	32,0 dB	26,2 dB
12 mm POLYCARBONATE CLEAR UV	34,0 dB	28,6 dB

Only EN 1793 applies as polycarbonate is not sound absorbing. The EN 1793 is in fact similar to the ZTV tests, but it has a different requirement (24 dB) which is met with polycarbonate. Differences towards ZTV are the increase of the frequency range to 5kHz (which for polycarbonate gives a better result). Sound attenuation values according to EN 1793 therefore are similar to the Rw values.



## 2 OUTDOOR NOISE REDUCING MEASURES

### 2.1 Noise barriers

An earthen noise barrier, has typically an angle of 45 degrees; therefore the width is double the height. This means that there is a lot of surface needed, which has to be filled with expensive soil. Alone for these reasons, earthen sound walls or berms are not so interesting anymore. A vertical sound wall is not expensive, as it hardly doesn't need any maintenance, and needs less expensive-space. Transparent noise barriers are mainly reflective.

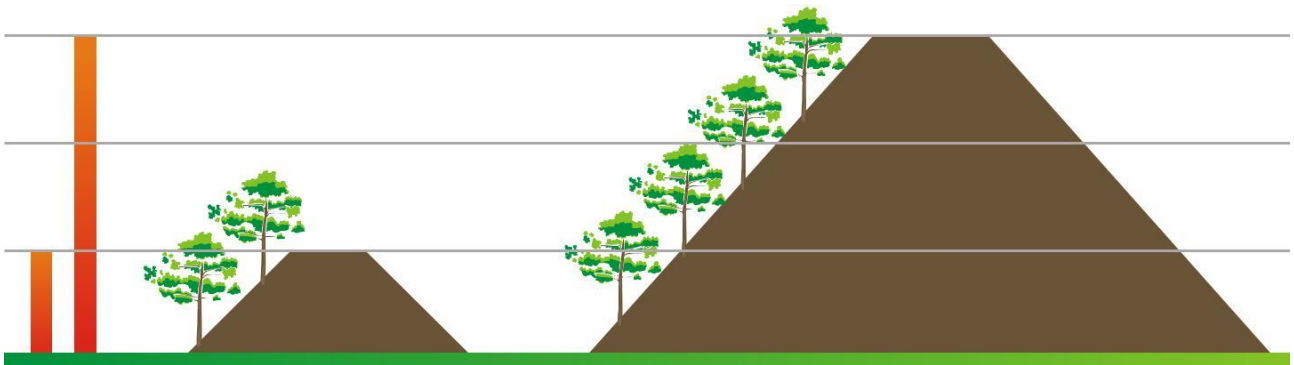

(surface occupation of vertical sound wall vs. earth sound barrier)

Wind speed changes with height to eaves: at ground level, speed is nearly zero, at greater heights, wind speed increases rapidly. This difference in wind speed is responsible for the bending behaviour of sound waves: sound waves encountering wind, will bend upwards, while sound waves which move in direction of wind, bend downwards.

This effect makes it difficult to design perfect sound walls. Therefore, it is recommended to use sound models to calculate the size of the sound walls, in order to obtain a minimum sound reduction. Areas where the sound waves are not projected to, are silent areas, and are indicated as "sound shade".

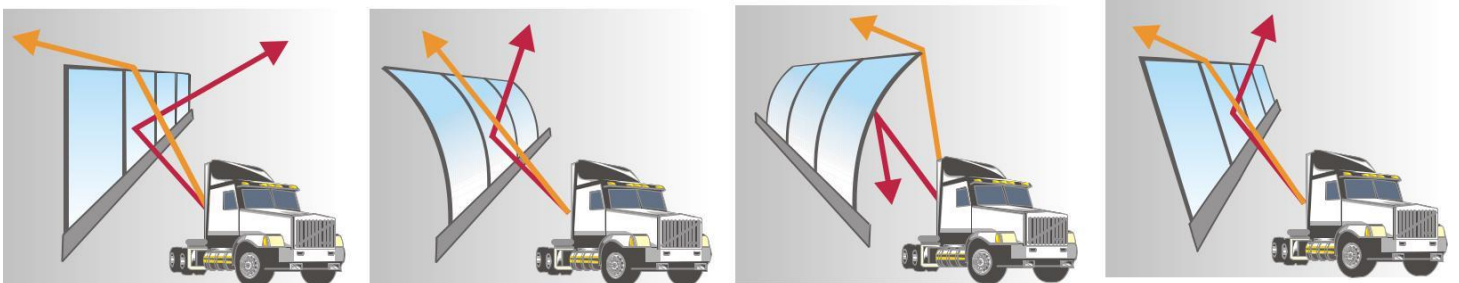
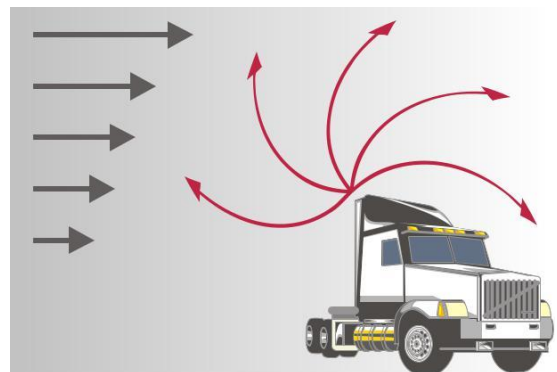

Types of sound walls. Most effective are the curved types, as reflected waves are projected to the sky. In the sound screen market new developments include screen tops. In order to avoid total renovation of the sound screen, special screen tops are developed to increase the sound reducing properties of the screens, without the need to drastically increase their height.

## 2.2 requirements and classifications

For a noise barrier, typically following properties are required:

1 light transmittance of at least 80% for clear panel

Light transmission decreases in function of thickness, at 15 mm light transmission is 80.5% for clear sheet.

2 Fire retardant properties

8 mm POLYCARBONATE CLEAR UV was tested to EN 1794-2 Brush wood fire test, and obtained class 2 rating.

3 Impact resistance to EN 1794-2

12 mm POLYCARBONATE CLEAR UV obtained highest class 6C for risk of falling fragments to EN 1794-2

Annex C

5 Sound reduction values of Arla Products

Values are valid for all solid sheet types of POLYCARBONATE CLEAR UV.

In the various standards, different test methods are used. Therefore results can not be compared on a single number. European legislation to European standards requires a value of min. 24 dB where formerly an STC of 25 dB was required for the ZTV LSW 88.

Sound Transmission Class (STC) according to ISO 717 compared to Rw to DIN 52210-75

Thickness	8 mm	10 mm	12 mm	15 mm
STC	31 dB	32 dB	34 dB	36 dB
ZTV Lsw 88	25 dB	26 dB	29 dB	31 dB

Numbers as such can not be compared, but graphs can:

Typical results for 8 mm POLYCARBONATE CLEAR UV, clamped on 4 sides in a frame.

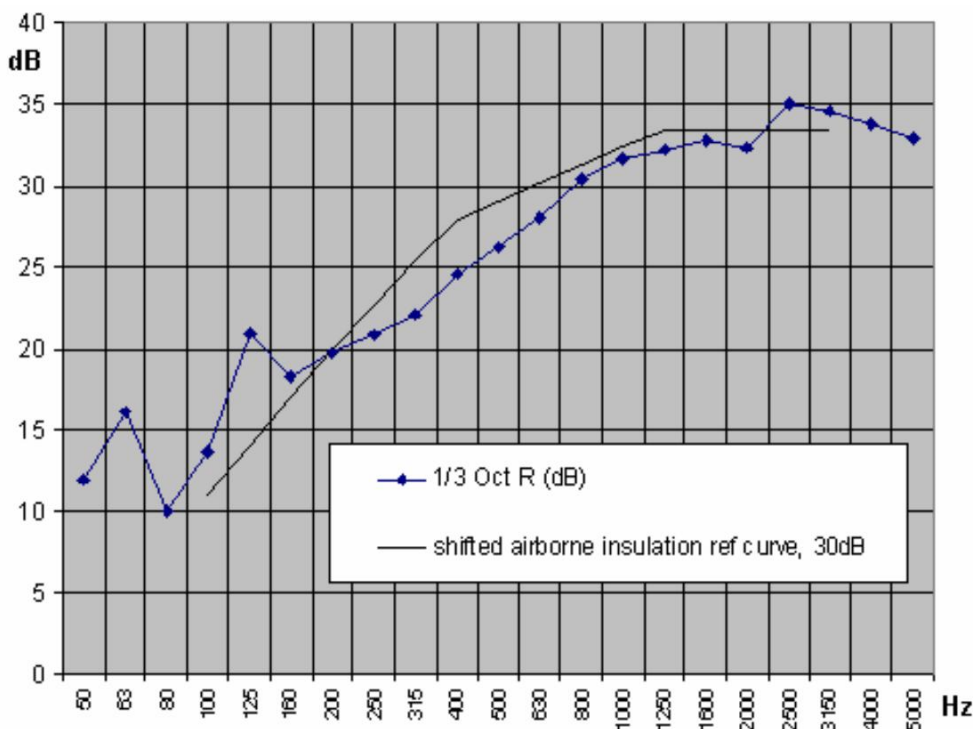

freq (Hz)	1/3 Oct R
50	12
63	16.1
80	10
100	13.6
125	21
160	18.3
200	19.7
250	20.9
315	22.1
400	24.6
500	26.3
630	28.1
800	30.4
1000	31.7
1250	32.2
1600	32.8
2000	32.3
2500	35
3150	34.6
4000	33.8
5000	32.9



The weighted sound reduction index to EN ISO 717-1  $R_w(C, C_{tr}, C_{50-5000}, C_{tr}, 50-5000) = 30$  (0; -4; 0; -5)  
 Single-number rating of airborne sound insulation performance as a difference to A-weighted sound pressure levels in accordance to EN 1793-2  $DLR = 26.4$  dB and belongs to category B3

Typical Polycarbonate solid sheet sound reduction estimated to DIN 55210-75 (R<sub>w</sub> value)

4 mm	5 mm	6 mm	8 mm	10 mm	12 mm
27 dB	28 dB	29 dB	31 dB	32 dB	34 dB

For MULTICLEAR® multiwall sheet, the sound reduction is ca 18-19 dB to EN ISO 717-1:

MULTICLEAR® BOX 2W	8-10 mm	18 dB
MULTICLEAR® STRONG	10 mm	18 dB
MULTICLEAR® STRONG	16-25 mm	19 dB
MULTICLEAR® LIGHT	32 mm	19 dB

### Sound screen

A sound screen is an effective method to reduce sound annoyance in air. Therefore a sound screen is also applicable in indoor applications such as offices.

Sound screens are mainly used to reduce sound caused by road traffic or train traffic. As sound can not travel through the screen, as the screen has sufficient surface mass, it will create a sound shade, similar to a light shade.

Therefore it is obvious that when you can see the source of sound over the sound screen, it will have no effect for this person.

Like with light shades, sound shades are not straight, as sound can bend over the screen. The longer path length that the sound has to make till the receiver, the better the screen works. Therefore, a higher sound screen is more effective than a low screen.

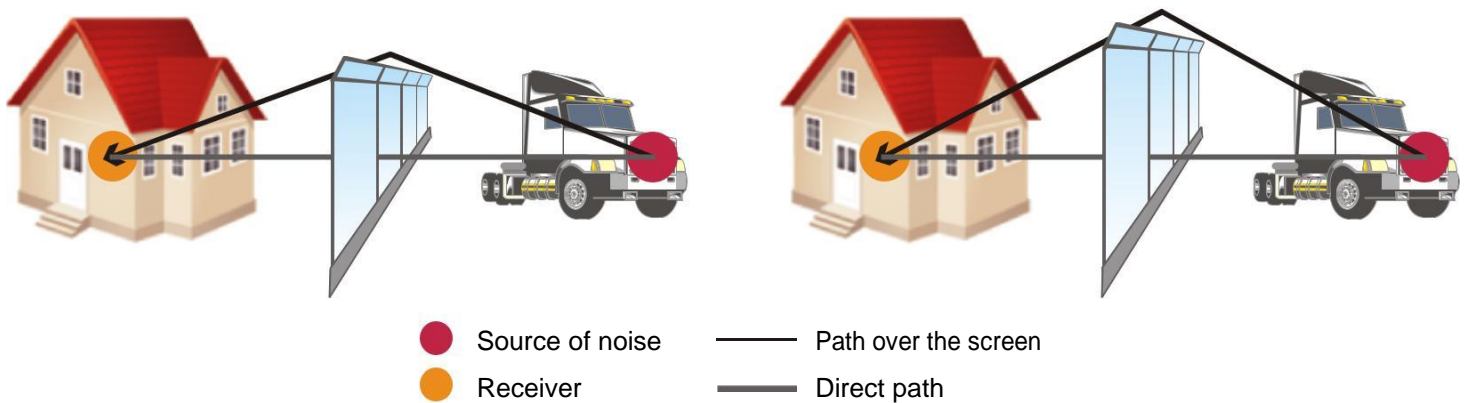

The higher the screen the longer the path of sound, thus the better the sound reduction. For the same reason is the effect of a sound wall less on longer distances.

The ratio between wave length and path of sound determines the sound reduction of a screen via a complex relation. In number of waves, the detour low frequency sound has to make, is small than for high frequency sound, which is the reason why an acoustic screen is less effective for low frequencies. Therefore the screen action varies as a function of the distance to the source, and the height of the receiver. An example for a double line railroad.

Sound reduction in function of screen height (1, 2 and 4 meter)

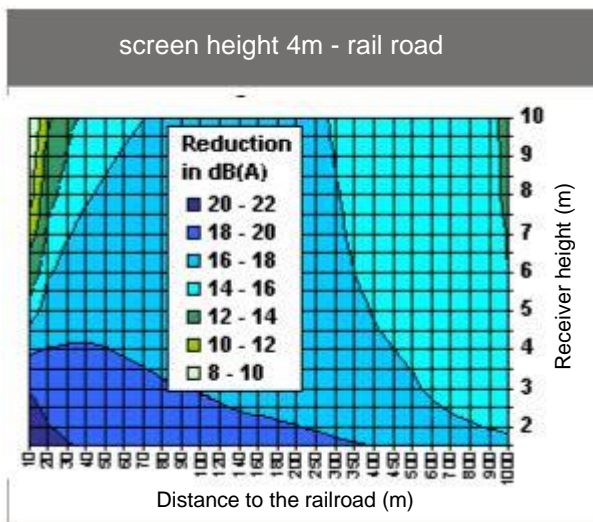
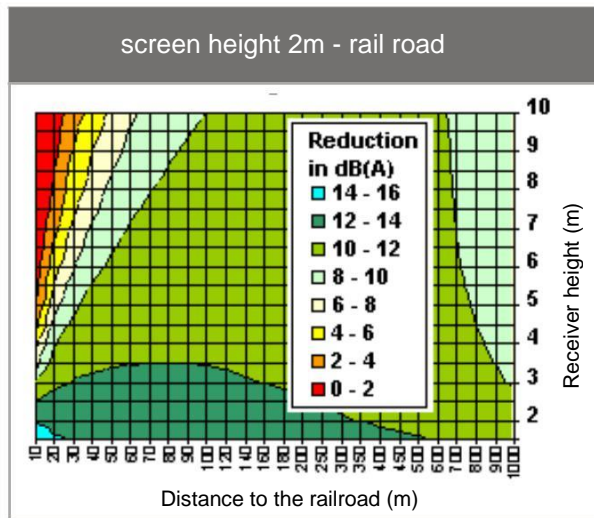
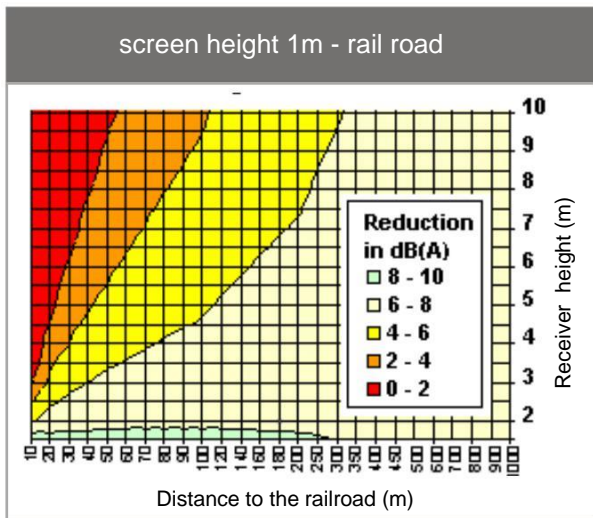

Sound reduction also depends on the size of the source. Therefore a three-lane highway often requires a higher screen than a relative narrow rail road. This effect is even enhanced due to the fact that a screen can be placed right next to the railroad, where on a highway often an emergency lane is included.

Fixing method:

In general, any fixing method should avoid direct metal contact, and should be sound-tight. Additionally, the fixing method should leave sufficient space for thermal movement, since polycarbonate sheet has a larger coefficient of linear thermal expansion than that of the glazing profiles commonly used. Allowance for thermal expansion must be made for both length and width of the sheet.

Coefficient of dilatation (x 10<sup>-6</sup> m/m °C )

Polycarbonate	Glass	Steel	Aluminium
67	7-9	12-15	21-23

Instead of calculations, indication of expansion is to use 3.5 mm per meter.

Fragile sound wall materials, which can break into sharp fragments when impacted, such as glass or PMMA are not allowed to be used on bridges, as parts can fall down and become hazardous. Polycarbonate has a very high impact resistance, and it is unlikely that a sheet will break. But when clamped in a frame, the sheet might come out as a whole. Therefore in those cases it is sufficient to secure the sheet on some points with a steel wire to the frame. Therefore such fixing method should be chosen that this does not influence the dilatational movement of the sheet.

Typical dry or wet sealing methods (top view)

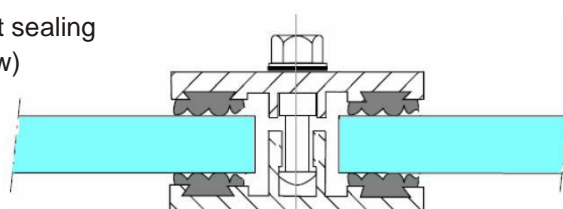

Dry sealing with compatible gasket

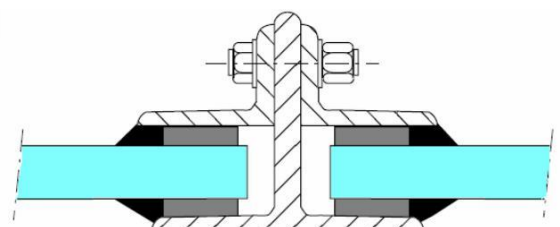

Wet sealing with compatible sealing product

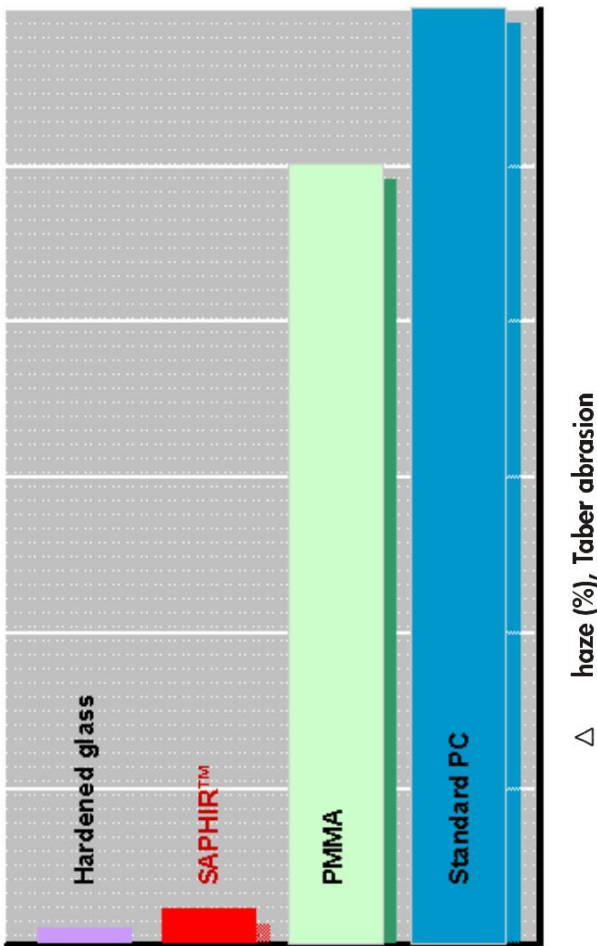

Resistance to industrial brush cleaning systems. When screens are regularly cleaned with industrial brush cleaning systems, it is recommended to use scratch resistant hard coated POLYCARBONATE CLEAR UV sheet (for flat glazing only).

In areas exposed to vandalism, POLYCARBONATE CLEAR UV hard coated sheet offers the best protection. Even graffiti and paints are easily removed, due to its extremely smooth and chemically inert surface.

When bird repellent stripes are needed, POLYCARBONATE CLEAR UV is recommended, as it combines a screen-printed design with the abrasion resistant surface of the POLYCARBONATE CLEAR UV sheet.



Dimension of sheet surface

Maximum sheet size depends on sheet thickness, wind/snow load, and clamping method.

Four side clamping gives a stiffer sheet than a three side clamped sheet.

Solid polycarbonate sheet POLYCARBONATE CLEAR UV can also be formed into a more rigid form, e.g., by zigzagging the sheet or by bending the sheet on one or two sides, or by curving the sheet in a radius.

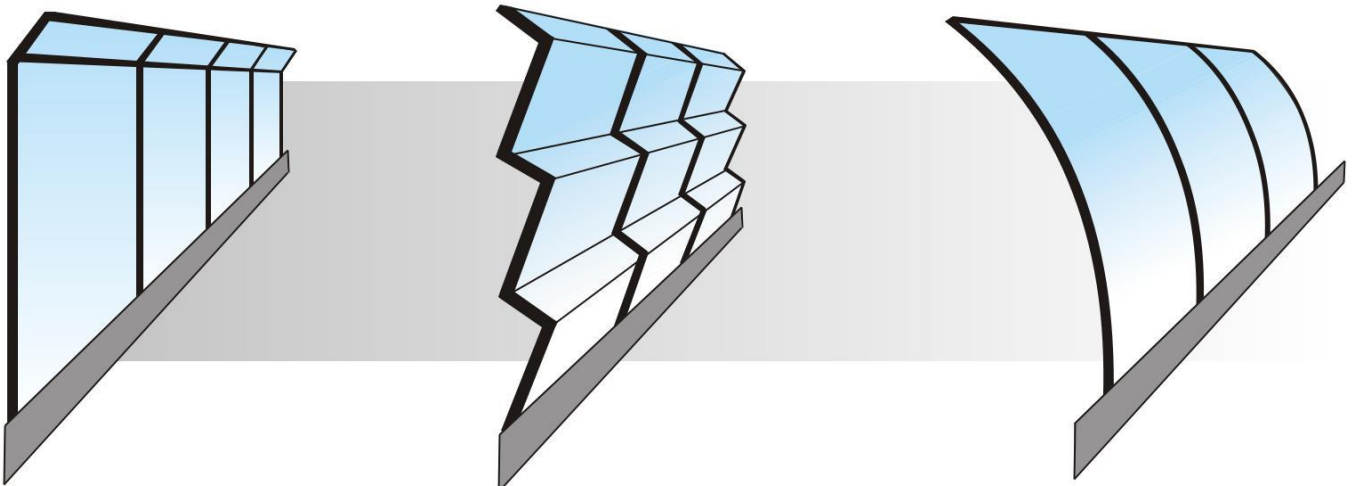

Minimum thickness depends on sound reduction requirements.

Following graphs are valid for flat sheet, clamped on 4 sides.

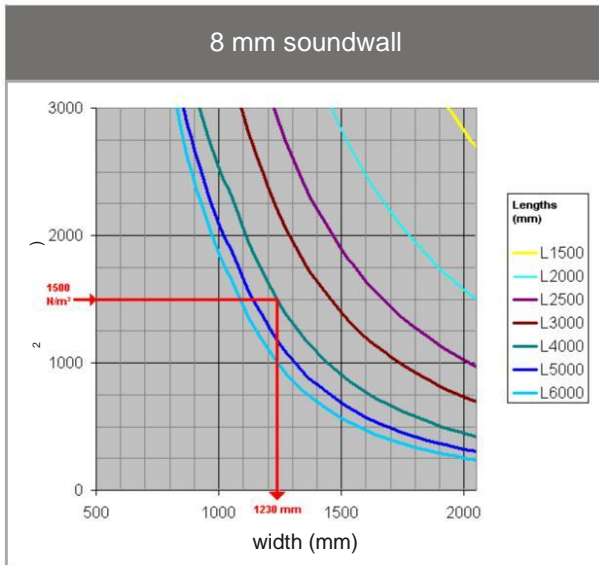

It is also valid for sheet curved in a radius when enclosed angle is smaller than 30 degrees:

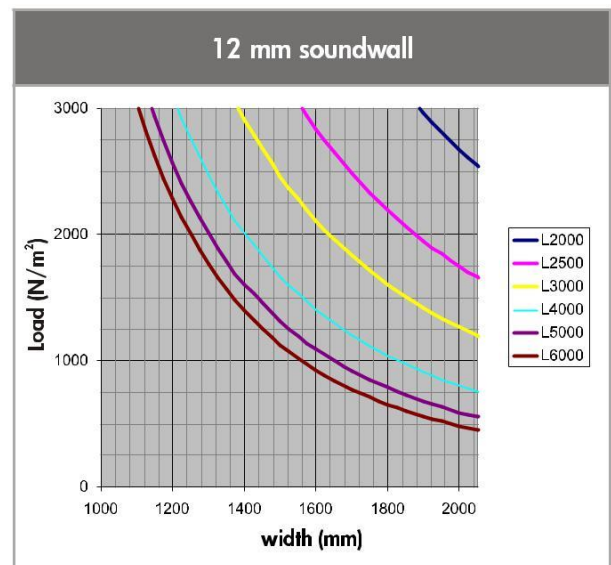
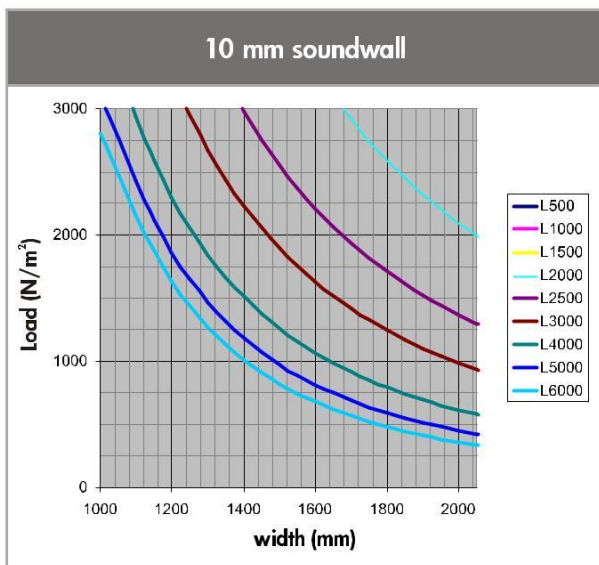

**Example:**

8 mm POLYCARBONATE CLEAR UV is needed for sound reduction.

Wind load is 1500 N/m<sup>2</sup>

Screen height is 3800 mm => next graph is L4000 mm

=> Maximum sheet width is 1230 mm.

If a larger width is wished, sheet thickness has to be increased.  
(for 10 mm, max width is 1400 mm).

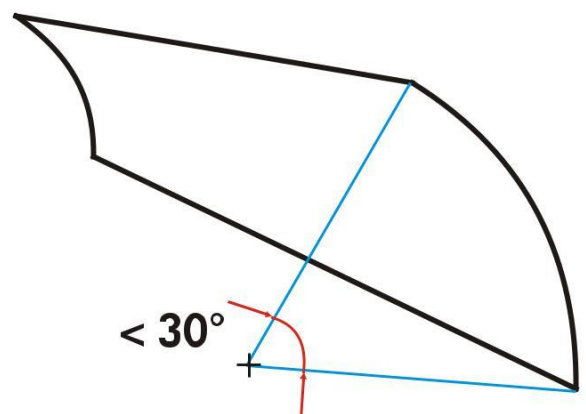

### 3 INDOOR NOISE REDUCING MEASURES

A change of 10 dB is perceived as a halving (doubling) of the noise level. Therefore, noise reducing measures are mostly regarded as very pleasing.

#### 3.1 double glazing

Installing POLYCARBONATE CLEAR UV solid sheet into single or double glazing systems, meets the acoustic requirements of today's glazing.

Where applicable, also textured types like TEX and ICE can be used, where privacy glazing is a requirement.

Alternatively, also MULTICLEAR® can be a cost-effective glazing material.

Double (or multiple) glazing using polycarbonate sheets need to be able to absorb temperature movements, and, need to be at a distance large enough that surfaces can not touch each other even when under extreme load.

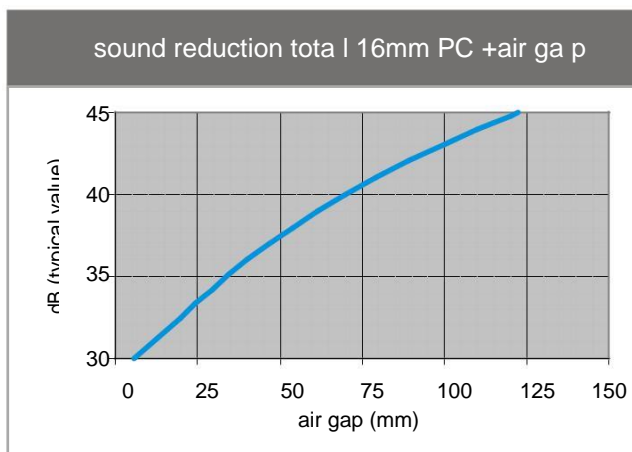

Sound reduction estimation for double glazed units, in function of air gap between two sheets. This graph is valid for a total polycarbonate thickness of 16 mm (i.e. 8 + 8 mm, or 12 + 4 mm etc)

It remains an estimate as its sound reduction very much depends on sheet size and clamping method and materials used.

Every doubling of the total thickness will add roughly 3 dB; every halving will deduct 3 dB.

Example:

4+4 mm with 75 mm gap will have ca. 37 dB.



### 3.2 secondary glazing (overhead glazing)

In order to reduce sound through glazing in buildings, it is possible to use overhead glazing (typically on the inside). Installing our solid sheet into single or double glazing systems, meets the acoustic requirements of today's glazing.

Today's typical factory made double glazing has a resonance frequency between 200 and 400 Hz. Much of the sound energy from aircraft or road traffic falls within this frequency range. By using our sheet in secondary glazing, the resonance frequency can be lowered to improve the insulation against such noise sources.

When applied together with existing glass and an air space of more than 40 mm, our solid sheet considerably reduces sound transmission, particularly at low frequencies, especially for traffic noise.

Unlike glass, humidity can pass through polycarbonate giving risk for condensation marks between the sheets. Ensuring a filtered air stream in between will take away this risk. Additionally it is recommended to clean the sheet prior to installation.

Doubling the sheet thickness increases the sound reduction with 3 dB.  
A change of 10 dB is perceived by humans as a halving (doubling) of the noise level.

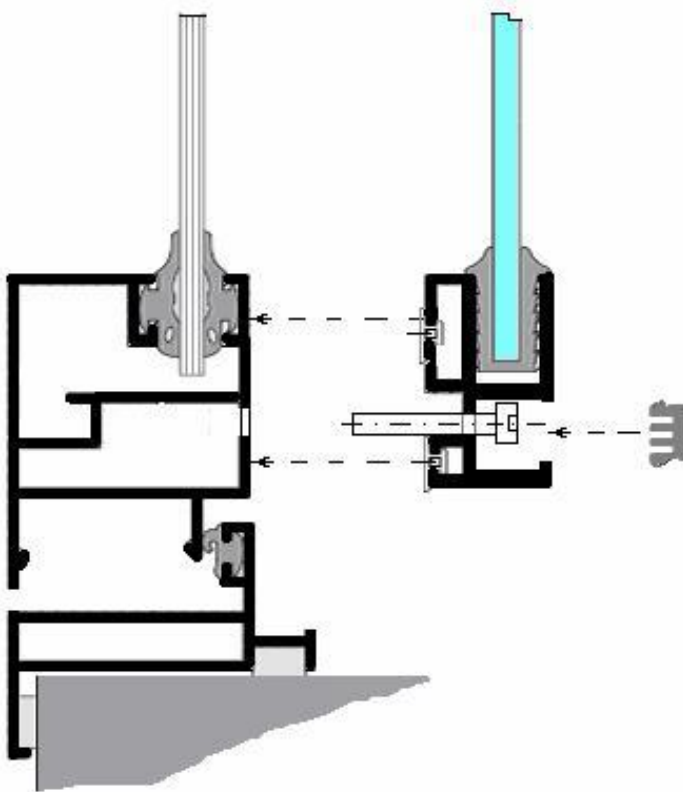

Noise has wave properties. This means that noise can pass through a window in two ways:

- 1.) Crack space or poor seals are responsible for letting noisy air enter through small spaces, allowing noise to amplify once inside.
- 2.) Vibration allows noise to travel through solid objects increasing noise levels inside. This means that to effectively reduce sound levels a window system should have minimal air infiltration and possess enough weight to limit vibration.

Using one thicker (e.g. 6mm) and one thinner (e.g. 3mm) pane may also help deaden sound because each pane is "transparent" to a different frequency and each pane will then attenuate the frequency that the other pane "passed". It also will avoid resonance of the glazing when one of the panes is vibrating.

Doubling the sheet thickness increases the sound reduction with 3 dB.  
Doubling the air gap increases the sound reduction with approx. 3 dB.  
A change of 10 dB is perceived by humans as a halving (doubling) of the noise level.

Typical Polycarbonate solid sheet sound reduction estimated to DIN 55210-75 (Rw value)

4 mm	5 mm	6 mm	8 mm	10 mm	12 mm
27 dB	28 dB	29 dB	31 dB	32 dB	34 dB

### 3.3 sound screen

---

Indoor sound screens like office screens can combine aesthetics with a technical solution.

For indoor application all Arla sheets can be used, but light-transmitting but diffusive screens will be preferred.

This includes GRIPHEN® FROST, POLYCARBONATE COLOURED FROST and MULTICLEAR® multiwall sheets.

All sheets can be formed in a radius (use minimum 100 times the sheet thickness).

UV resistant products are not an issue here, as normal indoor lighting at moderate distances hardly has a Ultraviolet compound.

Due to the fact that office screens mostly have the receiver very near to the screen, it is sufficient to use a height slightly over the receiver's height, in order to keep the receiver in the sound shade.

Also noisy office apparatus can be noise-insulated by a cover, but make sure sufficient ventilation is allowed.

Fire safety:

Our translucent sheet are self-extinguishing (oxygen index over 21%) and it will almost no contribution to the growth of flames through flame spread.

Our materials have been tested to the EN 13501 Euroclassification and obtained class B/C.

### 3.4 Machine glazing

---

For machine glazing, polycarbonate sheet are the ideal solution, due to its high impact resistance.

Sound reducing machine glazing requires double glazing with a large air gap.

Similar to double glazing in buildings, an asymmetrical build-up is preferred.

In some cases, GRIPHEN® sheet will be preferred due to its improved chemical resistance to oils.

For all flat glazing, POLYCARBONATE CLEAR UV sheet remain the best solution where it comes to enhanced scratch resistance and chemical resistance.

For more information: contact your local agent or contact Arla Plast directly.

